



CT Scanning

- Our CT Centre
- CT Scanners from RX Solutions
- CT Scanning Services
- CT Software
- CT Training

Our CT Centre

Welcome

At OR3D CT, we specialise in advanced in-house CT scanning services that provide precise and in-depth analysis across various industries. Our leading CT scanners from RX Solutions enables comprehensive data collection, leading to improved decision-making, enhanced quality assurance and faster turnaround times, including same-day results.

By working with a single CT scanning provider, our clients benefit from a streamlined process that builds deeper understanding, increases efficiency and ensures the delivery of more valuable and reliable data. Whether you require defect detection, material characterisation, or dimensional verification, our expertise guarantees high-precision results tailored to your specific needs.



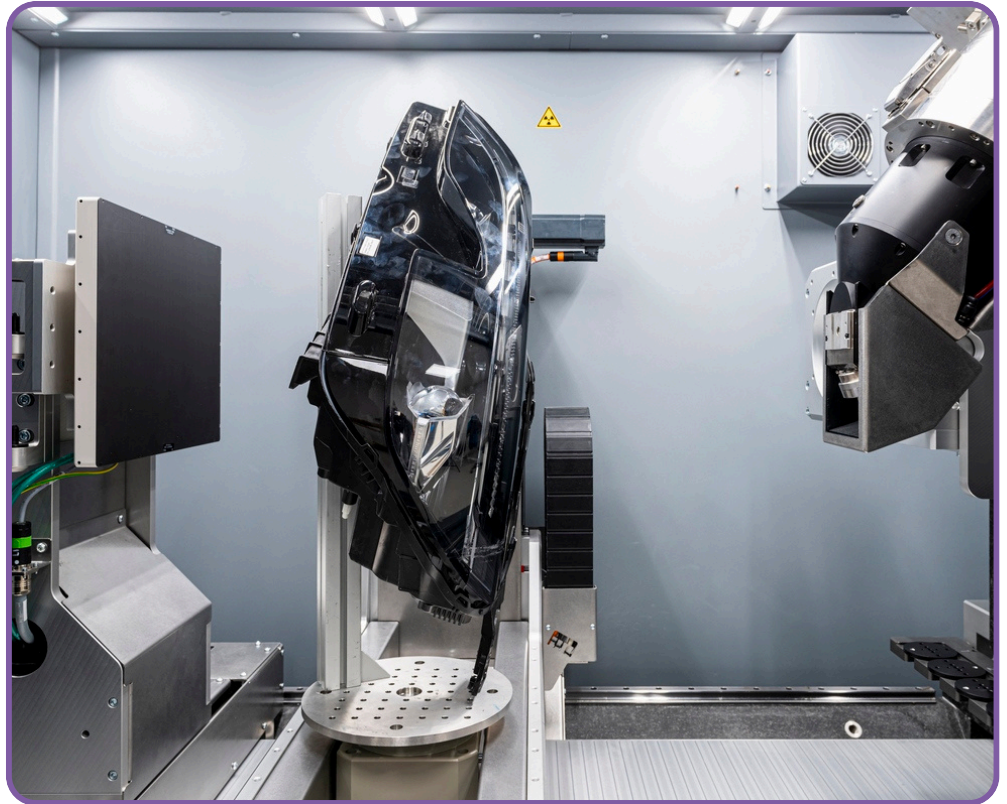
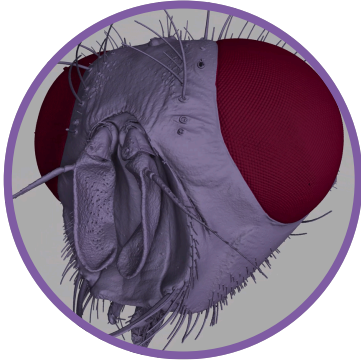
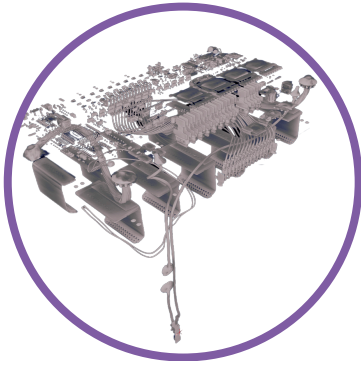

CT Scanning

OR3D's CT scanning technology enables high-resolution, non-destructive testing for a wide range of applications. Our systems utilise X-ray computed tomography to generate detailed volumetric data, allowing for the visualisation of internal structures, voids, inclusions and defects with micron-level accuracy. With advanced image reconstruction algorithms, we can provide highly detailed 3D models that facilitate precise measurements and comprehensive analysis of components.

We offer a spectrum of energy levels, from nano-focus systems for sub-micron resolution to high-energy 6 MeV accelerators for dense and complex materials. Our systems support multi-material scanning, automated defect detection, and quantitative material analysis, making them ideal for industries requiring stringent quality control and validation. With integrated metrology capabilities, our CT solutions enable dimensional inspection, geometric analysis, and reverse engineering with unmatched precision.

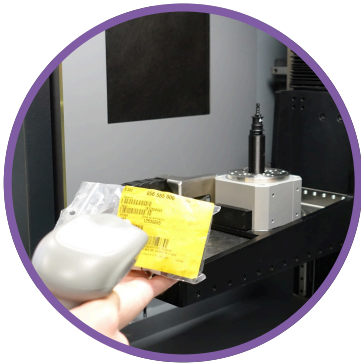
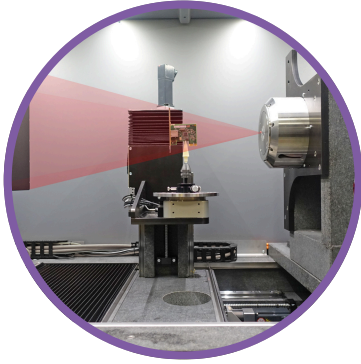

CT Scanners

At OR3D CT, the company employs industry-leading CT scanning systems to provide high-precision imaging and analysis. Their in-house best in class scanners include the EasyTom 230 and DeskTom, both from RX Solutions, enabling the company to meet a wide range of scanning requirements with exceptional accuracy and efficiency.

The EasyTom 230 is a versatile, high-resolution CT scanner, equipped with a powerful 230 kV X-ray source with a 2 μ m focal spot. This system is ideally suited for detailed internal inspections of complex components, delivering exceptional image clarity. With its capabilities for precise defect detection, porosity analysis and material characterisation, the EasyTom 230 is particularly valuable for industries such as

aerospace, automotive, and industrial applications, where thorough analysis and high penetration are critical. The system also supports a large scanning volume, further enhancing its flexibility for complex scanning needs.

The DeskTom, is a compact, high-precision CT scanner designed for smaller components and applications requiring fine detail. With advanced imaging capabilities and resolution, the DeskTom excels in industries demanding extreme accuracy, such as plastics and composite materials. Its efficient design allows for rapid scanning, making it an ideal choice for quality control, R&D and failure analysis, providing fast and reliable results.

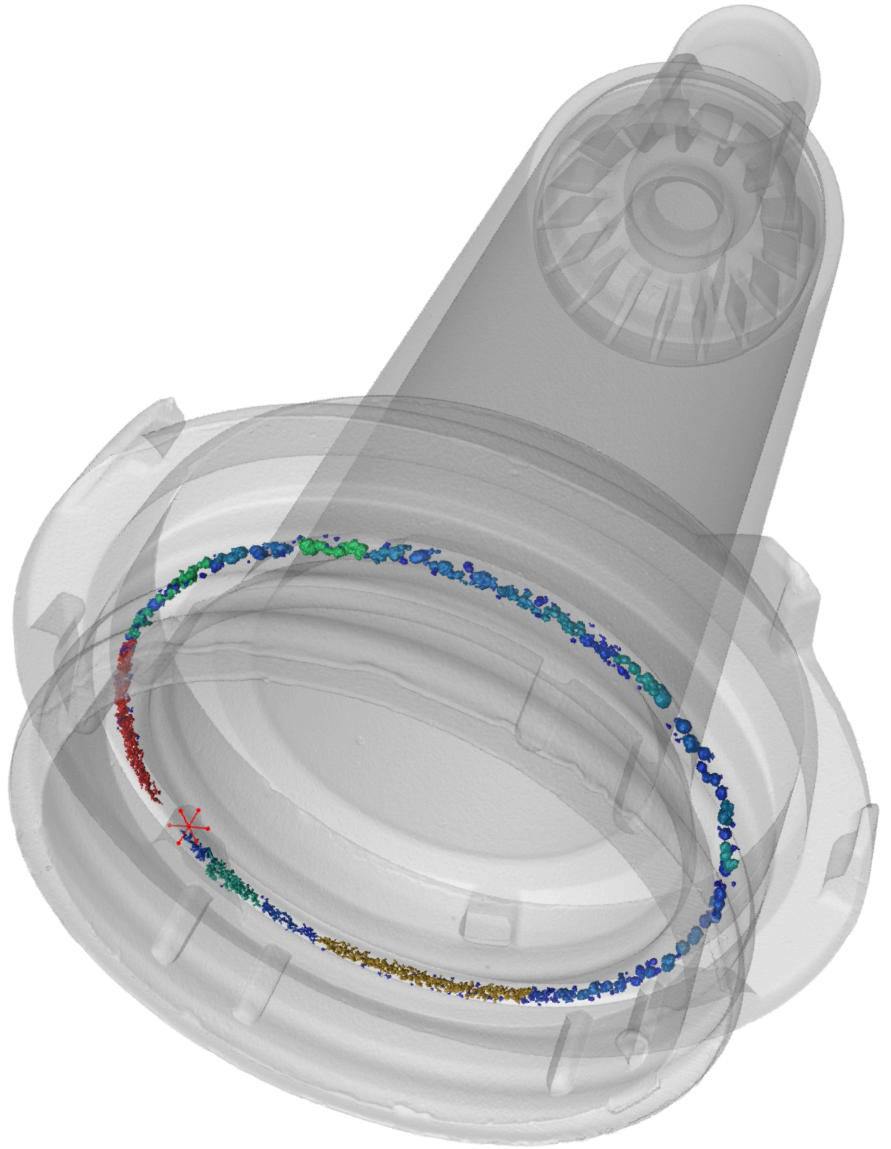
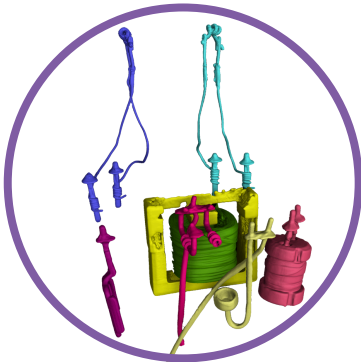
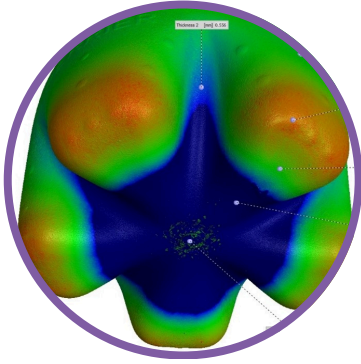

CT Services

OR3D CT offers a complete suite of CT scanning services designed to provide in-depth insights into material integrity, dimensional accuracy, and internal structures. Our expertise includes porosity analysis, which allows for the precise identification and quantification of voids, inclusions and material inconsistencies that could affect component performance. Through nominal-to-actual comparison, we ensure that manufactured parts conform to design specifications by mapping deviations between scanned components and CAD models.

For applications involving engineered porous materials, our foam structure analysis provides detailed assessments of cell morphology,

density variations and connectivity, supporting research and quality control in fields such as biomedical engineering and impact-resistant materials. Additionally, CT segmentation enables us to isolate specific materials or structural features within a scan, facilitating advanced multi-material analysis, defect detection and reverse engineering. Fibre analysis is also available, allowing for the characterisation of fibre orientation, distribution, and volume fraction, which is essential for evaluating composite materials and structural integrity.

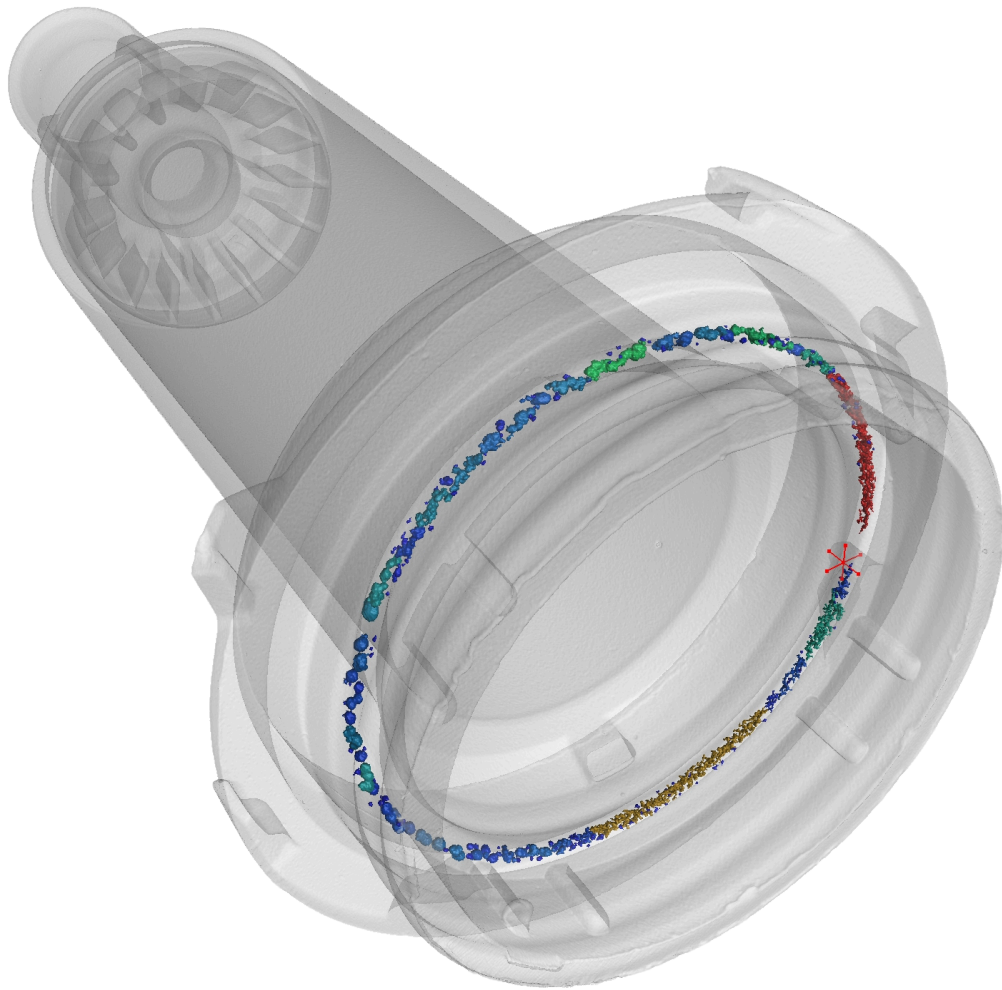

Porosity Analysis

Porosity analysis is a critical factor in evaluating the structural integrity and performance of materials, particularly in industries such as aerospace, automotive, and additive manufacturing. OR3D CT utilises high-resolution CT scanning to assess porosity distribution, pore morphology, and volumetric fraction with exceptional accuracy. Our advanced analysis techniques allow for the detection and quantification of voids, inclusions, and material inconsistencies that could impact component reliability.

Using voxel-based analysis and threshold segmentation, we can create precise 3D representations of porous structures, enabling engineers to assess the size, shape, and connectivity of voids. Our CT systems also support statistical porosity evaluations, providing comprehensive reports that include pore size distribution, location mapping and defect classification. This non-destructive approach ensures that critical components maintain optimal mechanical properties while meeting stringent industry standards.

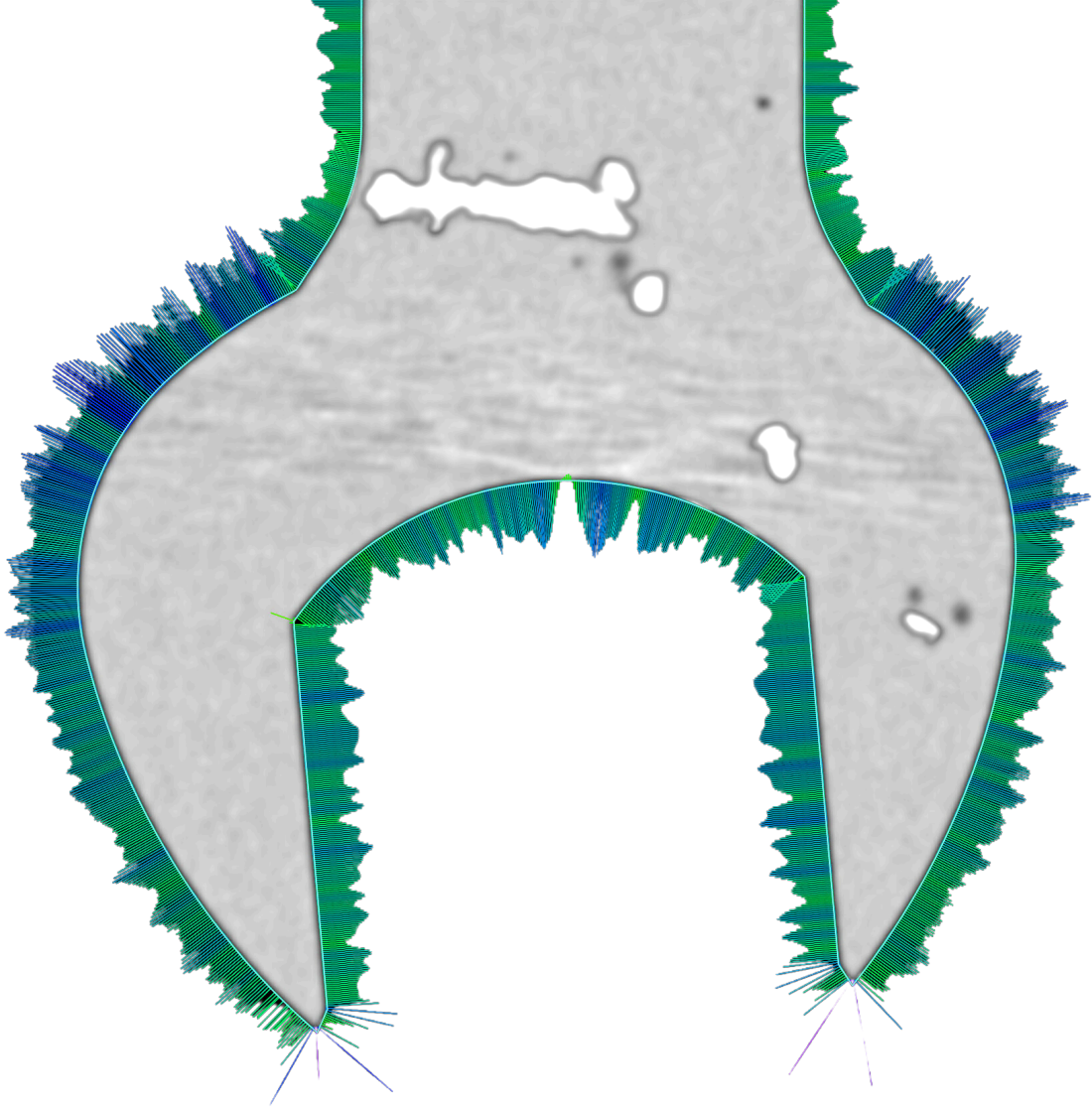

Nominal/Actual

OR3D CT's scanning technology allows for direct comparison between a scanned part and its nominal CAD model, ensuring precise deviation mapping and compliance with design specifications.

Our analysis process involves aligning the CT scan data with the nominal CAD model using best-fit algorithms and geometric constraints. Advanced color-coded deviation maps visually highlight any discrepancies, allowing for quick identification of warping, shrinkage, surface defects, or out-of-tolerance features.

By integrating nominal-to-actual CT analysis into quality control workflows, manufacturers can optimise production processes, reduce rework and ensure consistency in part performance. The non-destructive nature of CT scanning allows for complete internal and external analysis without compromising the integrity of the component, making it an invaluable tool for first article inspection, process validation, and failure investigations.

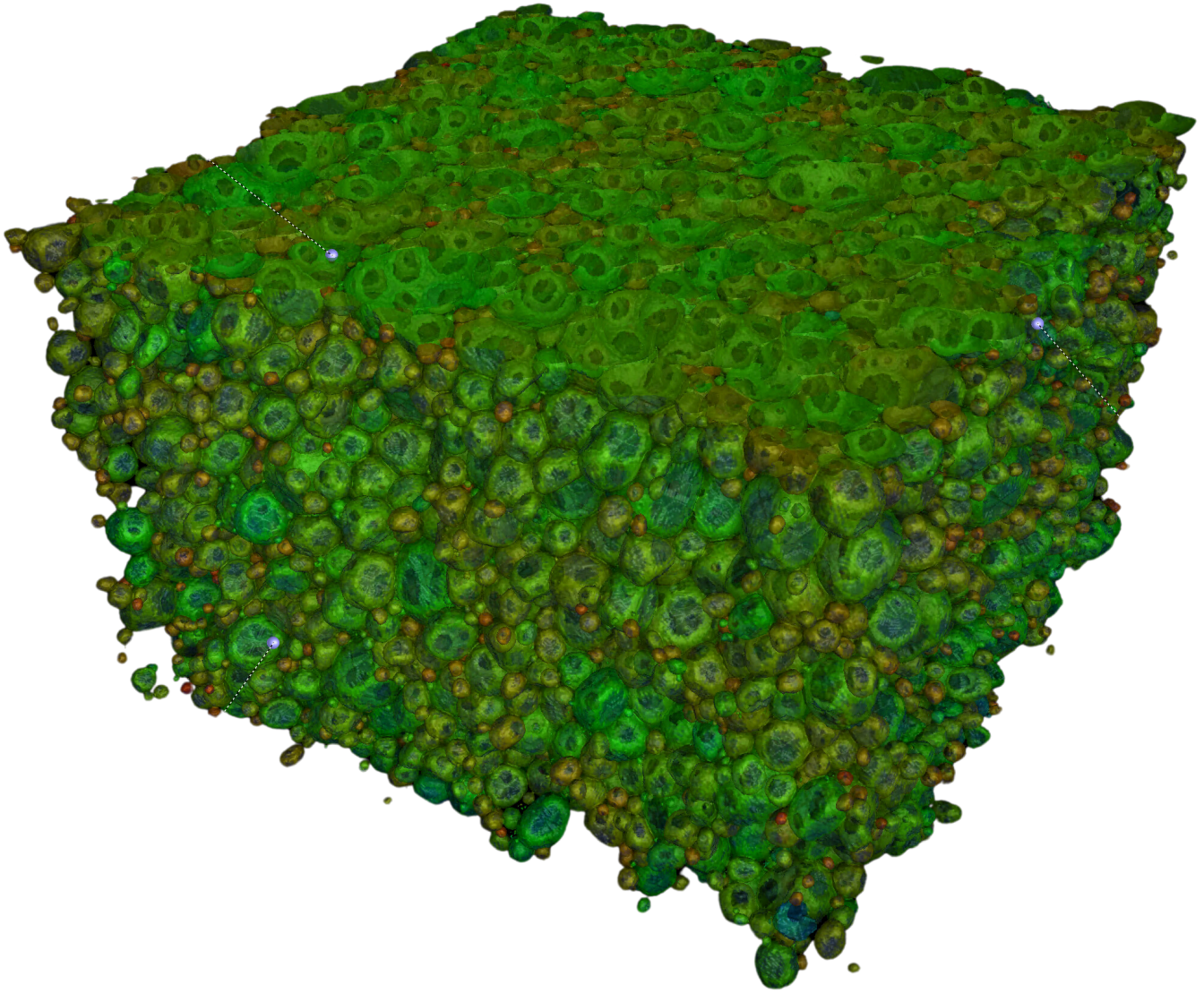

Foam Structure

Foam structures are widely used in industries such as aerospace, automotive, biomedical and packaging due to their lightweight properties and energy absorption capabilities. OR3D's CT scanning technology enables in-depth analysis of foam microstructures, providing critical insights into pore size distribution, cell connectivity, and density variations.

Our high-resolution CT systems capture the intricate cellular architecture of foams, allowing for detailed assessments of structural integrity, homogeneity, and potential defects such as voids or irregularities in cell formation.

By utilising advanced segmentation and thresholding techniques, we generate quantitative data on cell size distribution, anisotropy, and wall thickness, ensuring precise characterisation of foam materials.

Through non-destructive 3D visualisation, our foam analysis supports research and development efforts, process optimisation, and quality control in industries that rely on engineered porous materials.

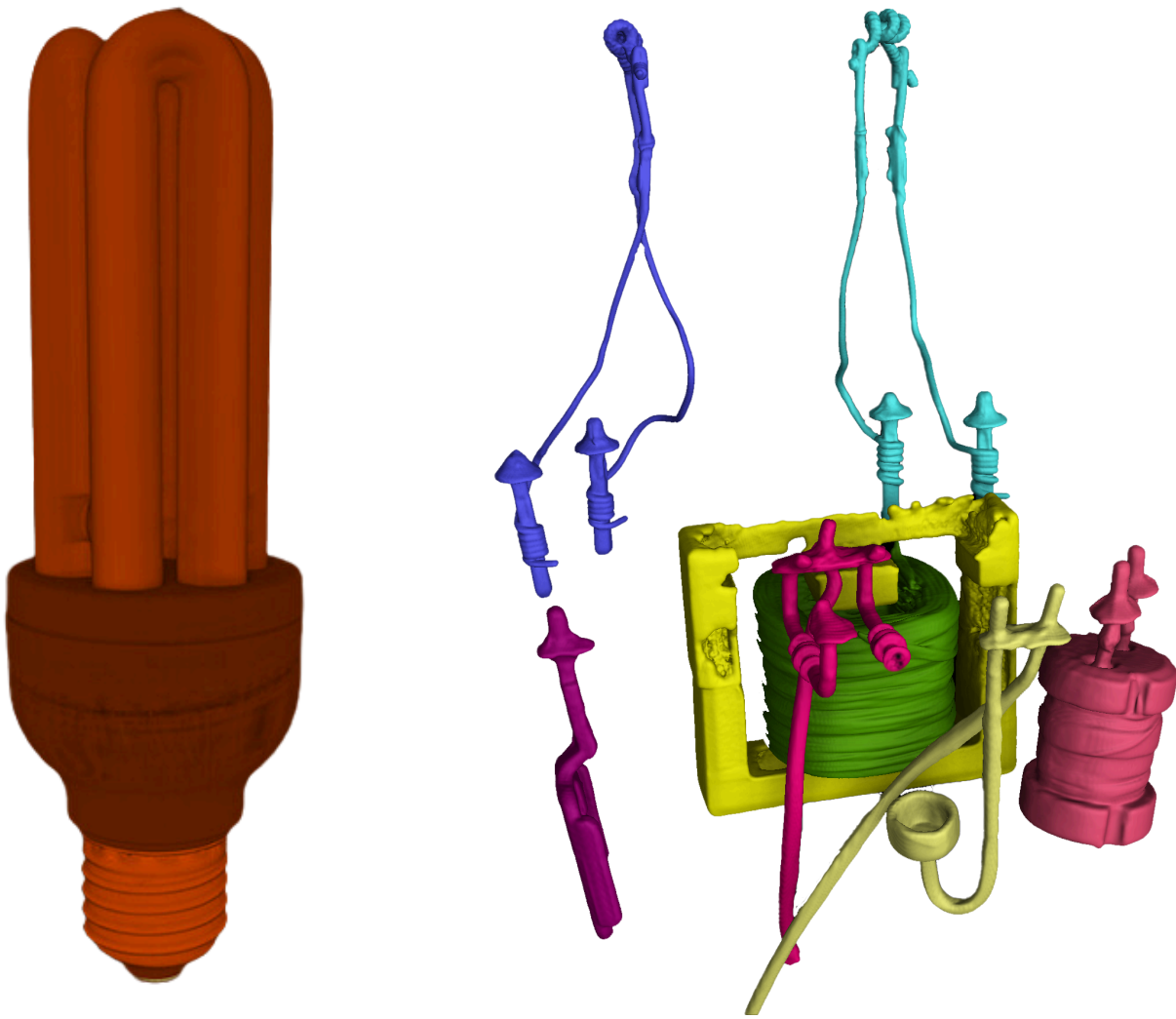

CT Segmentation

OR3D CT utilises advanced segmentation techniques to isolate specific materials, components, or defects within a scanned object, allowing for targeted inspection and enhanced visualisation.

Our segmentation process involves voxel-based classification and thresholding to distinguish different materials or structural features with high accuracy. This enables applications such as multi-material analysis, defect isolation and anatomical segmentation in biomedical research. The segmented data can be converted into high-fidelity 3D models for further analysis, reverse engineering, or computational simulations.

By leveraging automated and semi-automated segmentation workflows, OR3D CT ensures fast and reliable identification of key features within complex assemblies. Whether analysing composite structures, biomedical implants, or intricate mechanical components, our segmentation capabilities provide a deeper understanding of internal geometries and material distributions, enhancing both R&D and quality assurance processes.

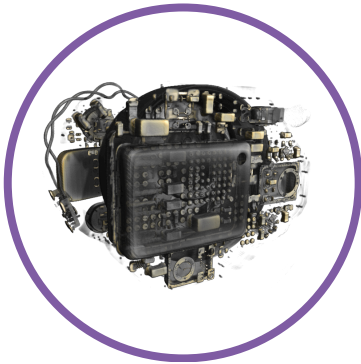
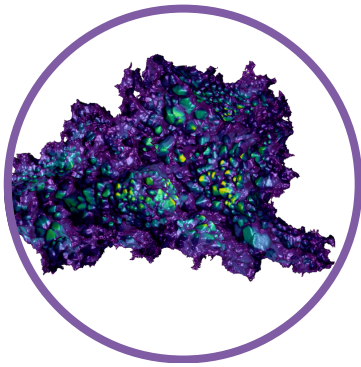

CT Software

The software used for processing and analysing CT data plays a crucial role in extracting meaningful insights from raw scan data, ensuring precision and reliability.

CT software enables the visualisation, measurement, and analysis of complex geometries in 3D space, enhancing product development, quality assurance and failure analysis. To optimise the capabilities of our CT scanning systems, we partner with industry leaders in CT analysis software - Volume Graphics and DragonFly.

These partnerships enhance our solutions by integrating specialised software tools that maximise the accuracy and efficiency of CT scans, providing unparalleled insights for industries ranging from aerospace to automotive and medical device manufacturing.



OR3Dct

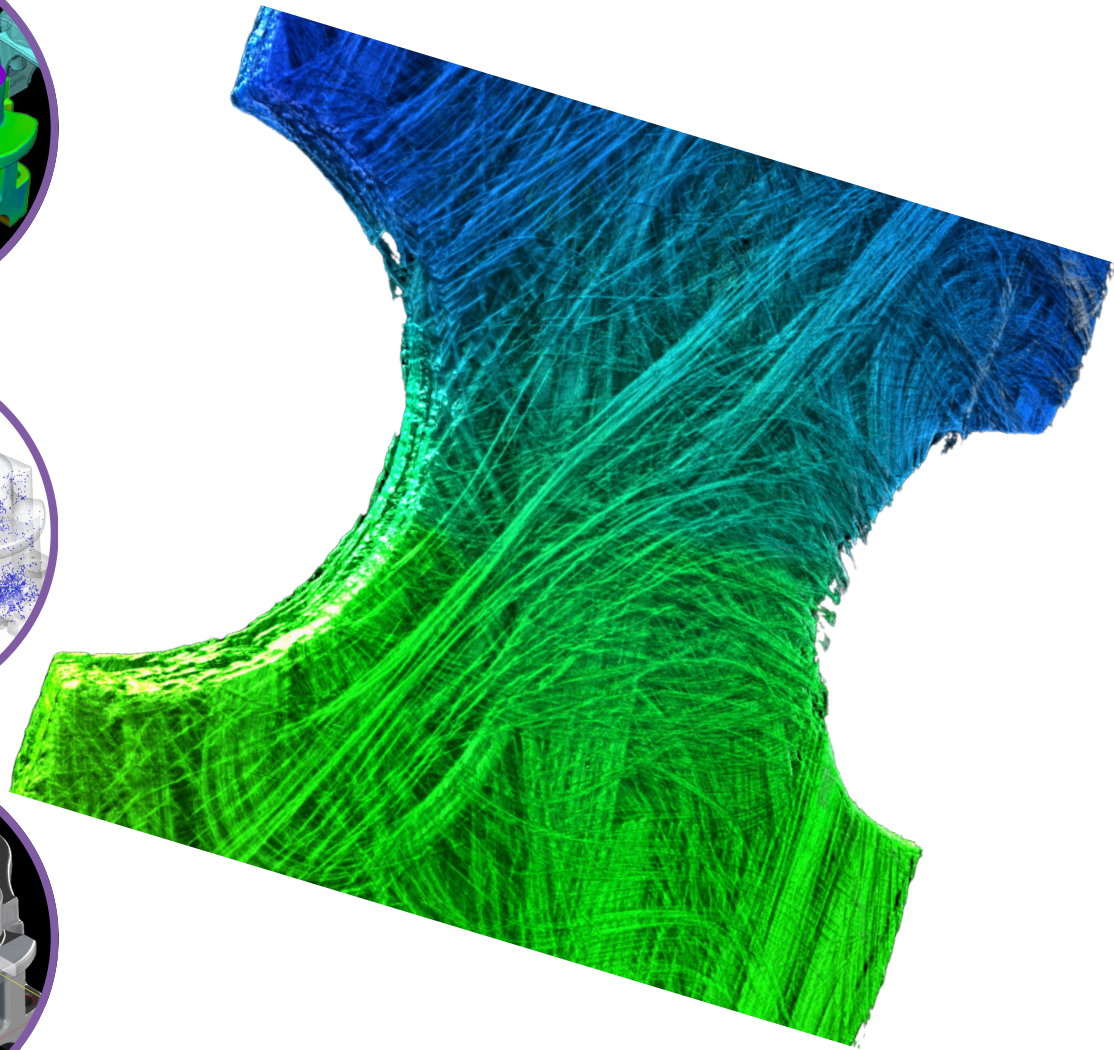
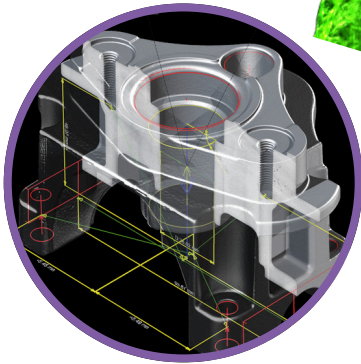
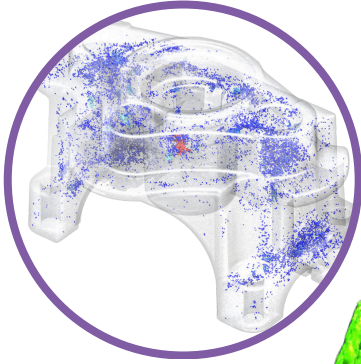
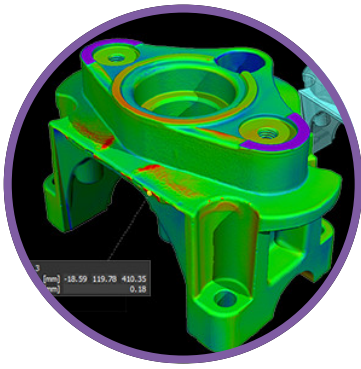

Volume Graphics

The software used for processing and analysing CT data plays a crucial role in extracting meaningful insights from raw scan data, ensuring precision and reliability.

CT software enables the visualisation, measurement and analysis of complex geometries in 3D space, enhancing product development, quality assurance and failure analysis. To optimise the capabilities of our CT scanning systems, we partner with industry leaders in CT analysis software - Volume Graphics and DragonFly.

These partnerships enhance our solutions by integrating specialised software tools that maximise the accuracy and efficiency of CT scans, providing unparalleled insights for industries ranging from aerospace to automotive and medical device manufacturing.



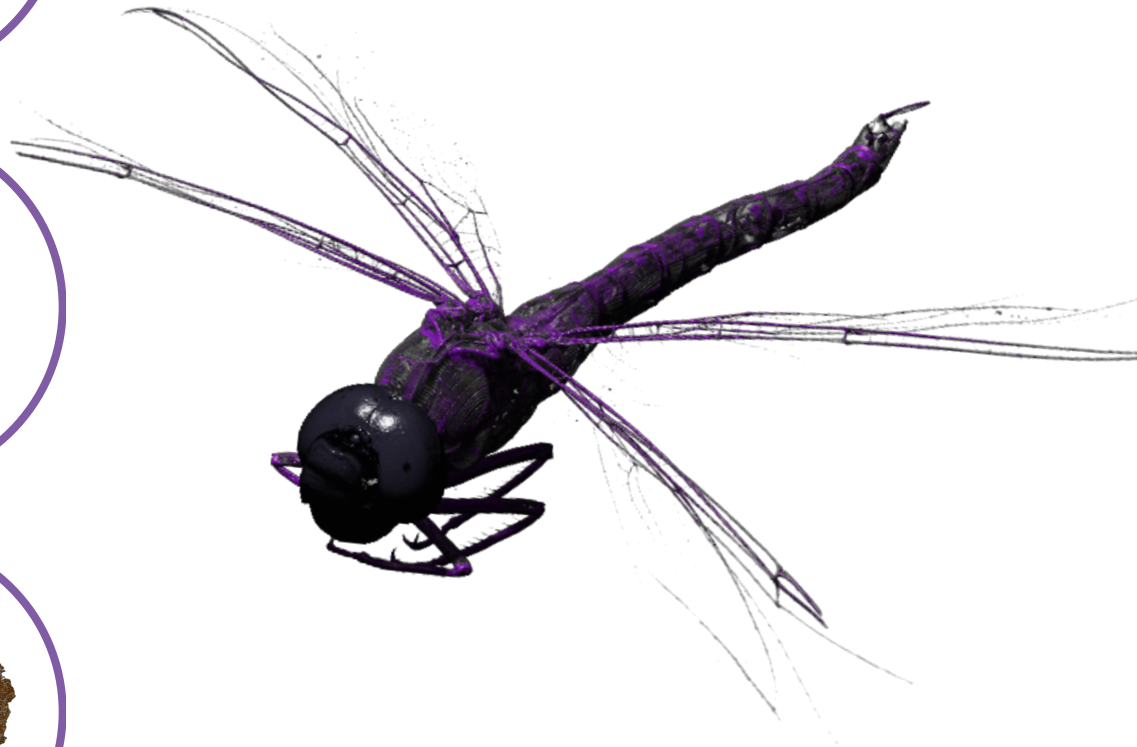
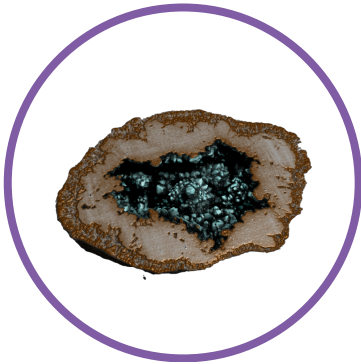

DragonFly

DragonFly is another critical partner that enhances our CT scanning offerings. DragonFly's powerful software platform excels in visualising and analysing CT scan data with advanced segmentation and 3D rendering techniques. It is particularly valued for its robust capabilities in handling large datasets, making it an ideal solution for industries dealing with intricate, high-resolution scans such as aerospace and automotive engineering.

A standout feature of DragonFly is its integration of artificial intelligence (AI) capabilities, which significantly enhance its data processing and analysis.

The AI-driven tools within DragonFly allow for automated segmentation and defect detection, improving both speed and accuracy in data interpretation. Machine learning models can be trained to identify specific features or anomalies, ensuring that critical patterns or issues that might be difficult to detect manually are highlighted efficiently. These AI features reduce human error, accelerate workflow and enable more complex analyses, allowing users to focus on actionable insights rather than spending time on manual processing tasks.

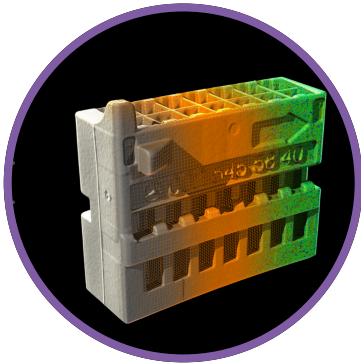
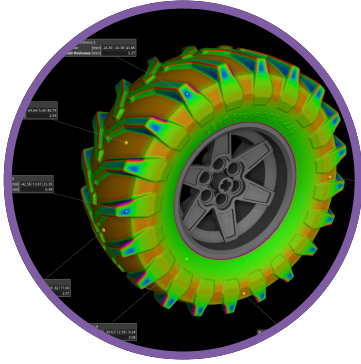
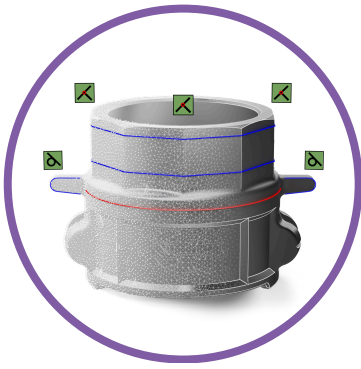

VG AUTHORIZED
TRAINER



**VOLUME
GRAPHICS**
VG ACADEMY

CT Training

As the sole training provider for Volume Graphics (VG) software in the UK and Ireland, OR3D CT delivers industry-leading training courses designed to maximise the potential of VGStudio Max and associated modules. Our expert-led training ensures users gain a comprehensive understanding of the software's powerful analysis and visualisation capabilities, enabling them to conduct precise CT data analysis, defect detection and metrology with confidence.

Not a VG user? We also provide introductory CT training, helping users get the most out of their scanners and inspection workflows. Additionally, training for Dragonfly software can be arranged upon request.

No matter the size or intricacy of your component, OR3D CT ensures the highest level of precision and reliability in every scan.

With a hands-on approach, we guide participants through real-world applications, covering key functionalities such as porosity analysis, nominal-to-actual comparison, wall thickness evaluation, and reverse engineering. Whether delivered on-site or remotely, OR3D CT's VG training empowers professionals across aerospace, automotive, medical, and manufacturing industries to optimise their CT analysis processes and enhance their inspection capabilities.

OR3Dct

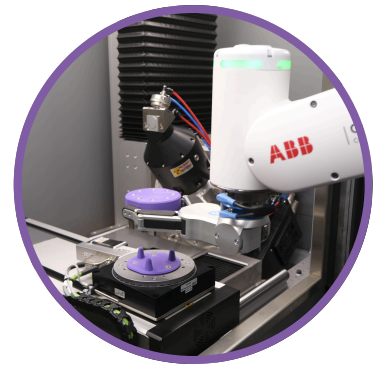

Lights-Out CT

OR3D CT offers fully automated overnight CT scanning using our ABB robotic arm. This lights-out automation system ensures continuous, high-precision scanning without the need for human intervention, maximising productivity and reducing lead times. The robotic arm seamlessly loads and unloads parts into our CT scanners, allowing for an uninterrupted workflow that accelerates data acquisition while maintaining exceptional accuracy and repeatability.

By utilising the ABB robotic arm for automated handling, OR3D CT provides a scalable solution for high-volume inspections, batch scanning, and complex component analysis. This system is ideal for industries requiring rapid throughput without compromising on quality, such as aerospace, automotive, and additive manufacturing.

With the ability to run overnight, clients can expect fully processed scan data ready for analysis at the start of the next working day, significantly improving efficiency and reducing downtime.

OR3Dct

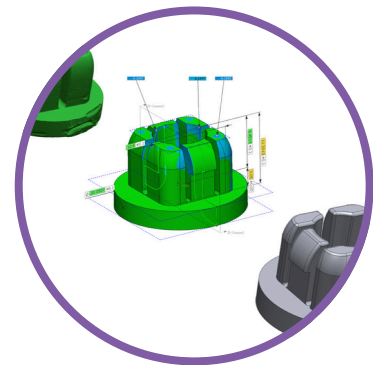
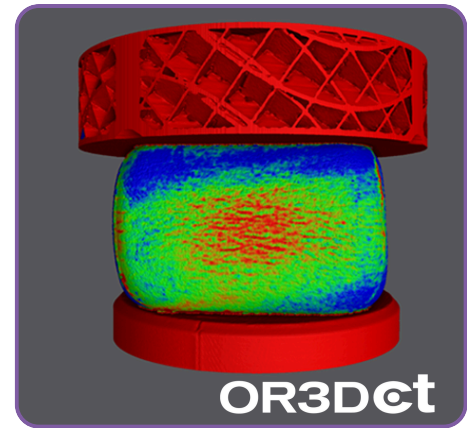
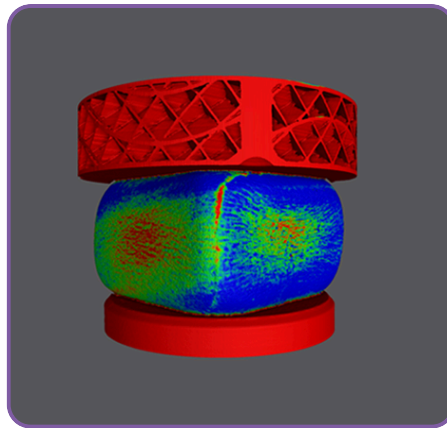
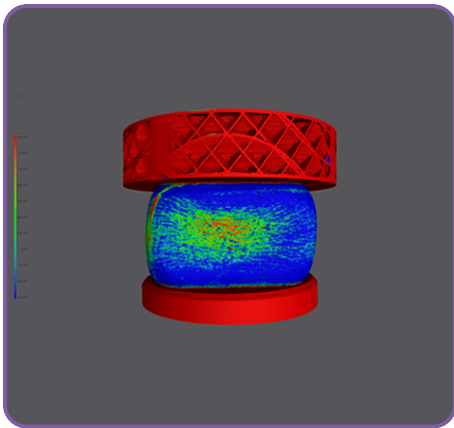

Consultancy

Beyond CT scanning, OR3D CT offers extensive metrology and inspection services, utilising a variety of 3D scanners and precision measurement tools. Our additional capabilities include dimensional metrology, advanced inspection software for defect detection and reverse engineering to create detailed CAD models from physical components. We also offer 4D CT scanning, enabling time-resolved analysis to capture changes in a component's structure under varying conditions.

We cater to a diverse range of industries, from biomedical research and aerospace to manufacturing and energy sectors.

No matter the size or intricacy of your component, OR3D CT ensures the highest level of precision and reliability in every scan.

With our expertise, industry-leading technology, and commitment to excellence, OR3D CT is your trusted partner for all CT scanning and metrology requirements. Contact us today to learn how our services can support your business and provide the critical insights you need for success.

Contact

3 Cedar Court, Brynkinalt Business Centre,

Chirk, Wrexham. LL14 5NS

01691 777 774

info@OR3D.co.uk

